



# 시험 성적서

<p><b>CTK Co., Ltd.</b> The Prime Leader of Global Regulatory Certification</p>	<p><b>(주)씨티케이</b> 경기도 용인시 처인구 동부로 221번길 5 (운학동) Tel: +82-31-339-9970 Fax: +82-31-624-9501</p>	<p>성적서 번호: <b>CTK-2023-01686</b> 페이지 (1) / (총 13)</p>
---	---	---

<p>1. 신청자</p> <p>상호명 : 주소 : 신청일자 :</p> <p>2. 제조자</p> <p>상호명 :</p> <p>3. 시험성적서의 용도 :</p> <p>4. 시험대상품목 / 시료명 :</p> <p>5. 시험기간 :</p> <p>6. 시험방법 :</p> <p>7. 시험환경 :</p> <p>8. 시험결과 :</p> <p>9. 시험장소 :</p>	<p>(주)세연테크 서울특별시 강서구 허준로 217, 4층 404호 (가양동, 가양테크노타운)</p> <p>2022-10-19</p> <p>(주)세연테크</p> <p>품질평가용</p> <p>네트워크 고해상도 카메라 / FW7940-PEM</p> <p>2022-10-19 부터 2022-10-20 까지</p> <p>KS C IEC 60529:2013</p> <p>온도: (20.0 ± 10.0) °C, 상대습도: (50.0 ± 25.0) %</p> <p>시험결과참조</p> <p><input checked="" type="checkbox"/> 고정시험실    <input type="checkbox"/> 현장시험 (경기도 용인시 처인구 동부로 221 번길 5)</p>
---	--

본 성적서에 나타난 결과는 시험의뢰인에 의해 제공된 시료(들)에만 참조하십시오.  
본 성적서는 (주)씨티케이의 서면동의 없이 무단 전재 및 복사를 할 수 없습니다.

확 인	실무자 성 명: 문 민 기 (서명)	기술책임자 성 명: 배 수 찬 (서명)
-----	------------------------	--------------------------

본 성적서는 한국인정기구의 “KS Q ISO/IEC 17025와 KOLAS 인정”과 관련이 없음.

2023-08-03

(주) 씨 티 케 이 (인)

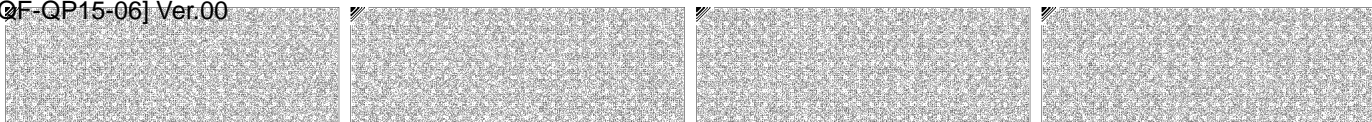

 <b>CTK Co., Ltd.</b> <small>The Prime Leader of Global Regulatory Compliance</small>	<b>쥬씨티케이</b> 경기도 용인시 처인구 동부로 221번길 5 (운학동) Tel: +82-31-339-9970 Fax: +82-31-624-9501	성적서 번호: <b>CTK-2023-01686</b> 페이지 (2) / (총 13)	
--	--	--	--

## 1. 외곽의 밀폐 보호 시험 (IP code)

### 1.1. 적용 규격: KS C IEC 60529:2013

### 1.2. IP 코드에 대한 보호 계급

코드문자 (International protection)

제 1특성 숫자 (0에서 6까지의 숫자 또는 문자 X)

제 2특성 숫자 (0에서 8까지의 숫자 또는 문자 X)

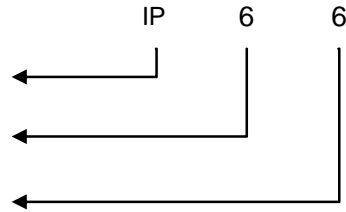

#### 1.2.1 위험한 부분으로의 접근에 대한 보호

제1특성 숫자	보호계급	적용여부
6	지름 1.0 mm 접근도 검사용 프로브가 침입하지 않고 또한 적정 공간 거리가 확보되어 있을 것.  누름 압력: 1 N ± 10 %	☑
주 제1특성숫자 3, 4, 5 및 6인 경우, 적정 공간거리가 확보되어 있으면 위험한 부분의 접근에 대해 보호되어 있는 것으로 취급한다. 기준표2의 규정과의 정합을 꾀하기 위해 “침입하지 않을 것 (shall not penetrate)”이라는 정의를 기준 표1에 넣었다. 제1특성숫자 1 및 2의 “전체가 침입하지 않고”란, 강구의 지름이 그 개구부를 통하여 빠져서는 안 된다는 뜻이다.		

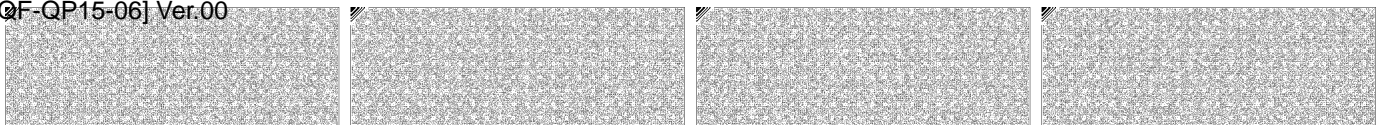

 <p><b>CTK Co., Ltd.</b> The Prime Leader of Global Regulatory Compliance</p>	<p><b>쥬씨티케이</b> 경기도 용인시 처인구 동부로 221번길 5 (운학동) Tel: +82-31-339-9970 Fax: +82-31-624-9501</p>	<p>성적서 번호: <b>CTK-2023-01686</b> 페이지 (3) / (총 13)</p>	
--	---	---	--

**1.2.2 외래고형물에 대한 보호**

제1특성 숫자	보호계급	적용여부
6	<p>먼지의 침입이 없을 것.</p> <p>외곽은 대기압 이하로 감압하는 일이 있으나 없으나 “카테고리1”로 보고, 피시험품 내부를 부압상태로 8시간 시험한다.</p> <p>(탈크분은 정해진 <math>\Phi 50 \mu\text{m}</math> 철사를 공칭 간격 <math>75 \mu\text{m}</math> 에서 직각으로 서로 배치한 사각형 망눈의 체를 통과하는 것일 것, 사용하는 탈크분량은 <math>2 \text{ kg/m}^3</math> 으로 한다.)</p> <p>제품 내용적 ..... : <b>2 514.46 cm<sup>3</sup> → 2.51 L</b></p> <p>목표흡입용적 (제품 내용적 80배) ..... : <b>201.16 L</b></p> <p>흡입용적 (최대 제품 내용적 60배 /시간) ..... : <b>150.87 LPH → 2.51 LPM</b></p> <p>실제흡입용적 ..... : <b>2.50 L</b></p> <p>흡입압력 (최대 2 kPa) ..... : <b>2 kPa</b></p> <p>시험시간 (최대 8시간) ..... : <b>8 시간</b></p>	☒
<p>주 <sup>(1)</sup>외곽 개구부를 고형물 검사용 프로브의 전체 지름 부분이 통과하여서는 안 된다.</p> <p>제1특성숫자 1 및 2의 “전체가 침입하지 않고”란, 강구의 지름이 그 개구부를 통하여 빠져서는 안 된다는 뜻이다.</p>		

**1.2.3 물에 대한 보호**

제2특성 숫자	보호 계급	적용여부
6	<p>모든 방향에서 강력한 제트 분류의 물이 해로운 영향을 주지 않을 것</p> <p>분류 노즐 기준 그림 6의 지름 12.5 mm 인 노즐 시험장치</p> <p>유량: 100 l/min ± 5 %</p> <p>거리: 2.5 m 에서 3 m 사이: <b>3 m</b></p> <p>시험 시간: 1 min/m<sup>2</sup> 최저 3분: <b>3 분</b></p>	☒

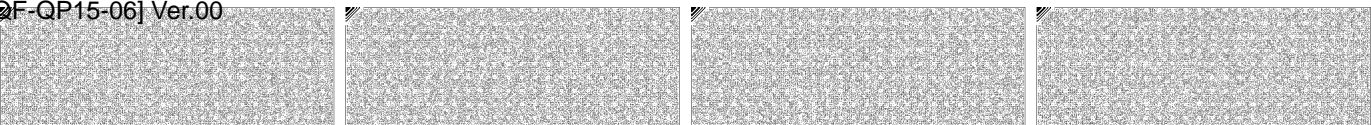

 <b>CTK Co., Ltd.</b> <small>The Prime Leader of Global Regulatory Compliance</small>	<b>쥬씨티케이</b> 경기도 용인시 처인구 동부로 221번길 5 (운학동) Tel: +82-31-339-9970 Fax: +82-31-624-9501	성적서 번호: <b>CTK-2023-01686</b> 페이지 (4) / (총 13)	
--	--	--	--

### 1.3. 시험결과

IP code	비고
IP 6X	프로브의 침입이 없음. 먼지 침입이 없음.
IP X6	물의 침입이 없음.

※ 본 시험 결과는 의뢰자가 제출한 시료에 대하여 시험한 결과임



 <p><b>CTK Co., Ltd.</b> <small>The Prime Leader of Global Regulatory Compliance</small></p>	<p><b>㈜씨티케이</b> 경기도 용인시 처인구 동부로 221번길 5 (운학동) Tel: +82-31-339-9970 Fax: +82-31-624-9501</p>	<p>성적서 번호: <b>CTK-2023-01686</b> 페이지 (5) / (총 13)</p>	
---	---	---	--

**모델 명세**

대표 모델 (시험모델) .....	FW7940-PEM
파생모델명 .....	FW7940-PSM
모델 차이점 .....	단순파생

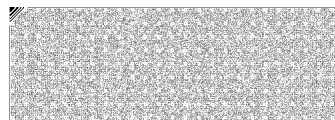

 <b>CTK Co., Ltd.</b> <small>The Prime Leader of Global Regulatory Compliance</small>	<b>쥬씨티케이</b> 경기도 용인시 처인구 동부로 221번길 5 (운학동) Tel: +82-31-339-9970 Fax: +82-31-624-9501	성적서 번호: <b>CTK-2023-01686</b> 페이지 (6) / (총 13)	
--	--	--	--

### 시험설비 목록

Instrument type	Model	Make	Serial	Calibration Effective Date
Stop Watch	NONE	Casio	612Q01R-1	2023-03-03
Aneroid Barometer	BAROMEX	SATO	84682	2023-04-07
Hygro Thermograph	ST-50M	SEKONIC	HE51-000147	2022-10-19
Push Pull Gage	FB30K	Imada	83805	2023-02-22
Test wire (1.0 mm)	TRP-02	ED&D	S1-J15	-
Dust Chamber	NONE	JFM	S3-IP36	2023-07-06
Area flow meter	Z-6504	NURITECH	04	2023-01-03
Waterproof test apparatus	IPX3-6	Kingpo	0190309001	-





 <p>CTK Co., Ltd. The Prime Leader of Global Regulatory Compliance</p>	<p><b>쥬씨티케이</b> 경기도 용인시 처인구 동부로 221번길 5 (운학동) Tel: +82-31-339-9970 Fax: +82-31-624-9501</p>	<p>성적서 번호: CTK-2023-01686 페이지 (7) / (총 13)</p>	
---	---	--	--

## 2. 별첨

### 2.1. 제품 사진

<사진 1> 제품 전면



<사진 2> 제품 후면



 <p><b>CTK Co., Ltd.</b> <small>The Prime Leader of Global Regulatory Compliance</small></p>	<p><b>㈜씨티케이</b> 경기도 용인시 처인구 동부로 221번길 5 (운학동) Tel: +82-31-339-9970 Fax: +82-31-624-9501</p>	<p>성적서 번호: <b>CTK-2023-01686</b> 페이지 (8) / (총 13)</p>	
---	---	---	--

## 2.2. 시험 장면 사진

<사진 3> 제 1특성 숫자 시험 사진



<사진 4> 제 2특성 숫자 시험 사진

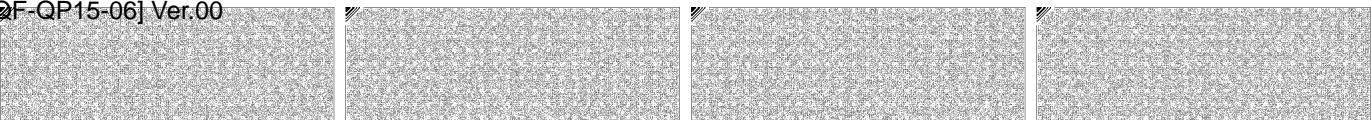



 <p>CTK Co., Ltd. The Prime Leader of Global Regulatory Compliance</p>	<p><b>㈜씨티케이</b> 경기도 용인시 처인구 동부로 221번길 5 (운학동) Tel: +82-31-339-9970 Fax: +82-31-624-9501</p>	<p>성적서 번호: CTK-2023-01686 페이지 (9) / (총 13)</p>	
---	---	--	--

### 2.3. 시험 후 제품 내부 사진

<사진 5> 제 1특성 숫자 시험 결과



<사진 6>



 <p><b>CTK Co., Ltd.</b> <small>The Prime Leader of Global Regulatory Compliance</small></p>	<p><b>쥬씨티케이</b> 경기도 용인시 처인구 동부로 221번길 5 (운학동) Tel: +82-31-339-9970 Fax: +82-31-624-9501</p>	<p>성적서 번호: <b>CTK-2023-01686</b> 페이지 (10) / (총 13)</p>	
---	---	--	--

<사진 7> 제 1특성 숫자 시험 결과

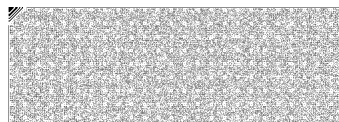





 <p><b>CTK Co., Ltd.</b> <small>The Prime Leader of Global Regulatory Compliance</small></p>	<p><b>㈜씨티케이</b> 경기도 용인시 처인구 동부로 221번길 5 (운학동) Tel: +82-31-339-9970 Fax: +82-31-624-9501</p>	<p>성적서 번호: <b>CTK-2023-01686</b> 페이지 (11) / (총 13)</p>	
---	---	--	--

<사진 8> 제 2특성 숫자 시험 결과

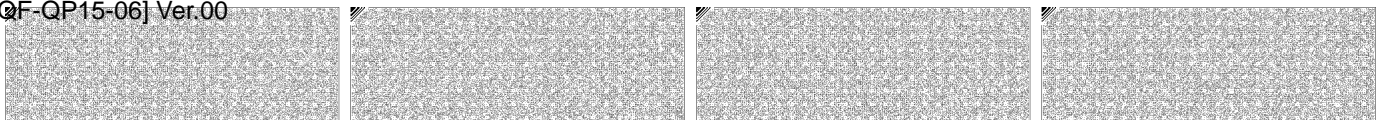

<사진 9>



 <p><b>CTK Co., Ltd.</b> <small>The Prime Leader of Global Regulatory Compliance</small></p>	<p><b>㈜씨티케이</b> 경기도 용인시 처인구 동부로 221번길 5 (운학동) Tel: +82-31-339-9970 Fax: +82-31-624-9501</p>	<p>성적서 번호: <b>CTK-2023-01686</b> 페이지 (12) / (총 13)</p>	
---	---	--	--

<사진 10> 제 2특성 숫자 시험 결과

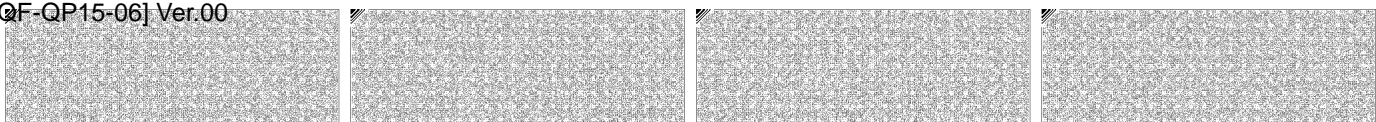



 <b>CTK Co., Ltd.</b> <small>The Prime Leader of Global Regulatory Compliance</small>	<b>쥬씨티케이</b> 경기도 용인시 처인구 동부로 221번길 5 (운학동) Tel: +82-31-339-9970 Fax: +82-31-624-9501	성적서 번호: <b>CTK-2023-01686</b> 페이지 (13) / (총 13)	
--	--	---	--

## 2.4. 제품 외관

외관 도면 [단위: mm]

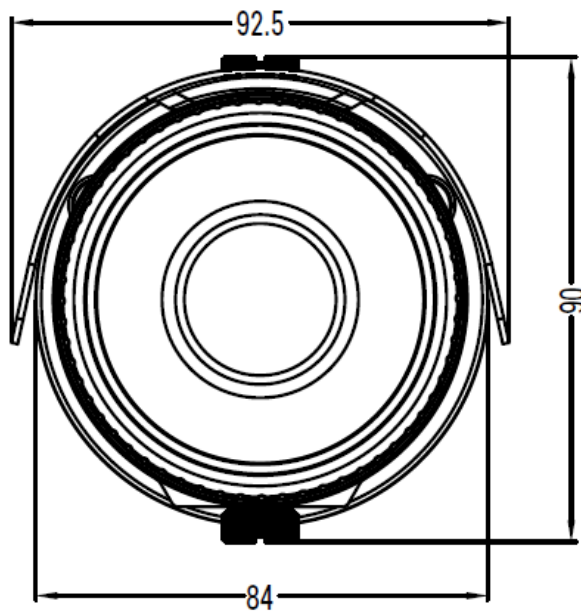
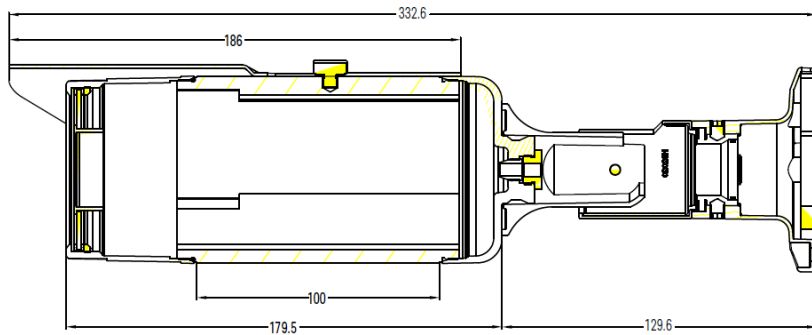
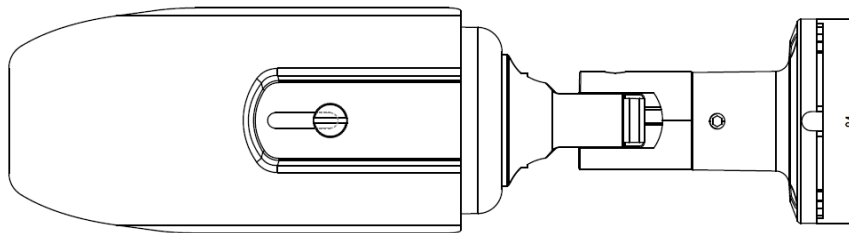

- 끝 -

